

Fanvil

SIP Audio Door Phone i23S

# Quick Installation Guide



[www.fanvil.com](http://www.fanvil.com)

## Table of Contents

1. Package Contents.....	3
2. Physical Specifications.....	4
3. Installation.....	8
4. Searching Door Phone.....	11
5. SIP Door Phone Setting.....	12
6. Door Unlocking Setting.....	14

## 1 Package Contents

---



Door Phone



Connectors



Quick Installation  
Guide



Mounting Template



RFIC Cards



Screw and  
Screwdriver

## 2 Physical Specifications

Device size	223 x 130 x 74mm
Weight	1800g

### 2.Physical Specifications

Device size	223 x 130 x 74mm
Weight	1800g

#### 1) Front Panel







Interface	Description
Speaker	The door phone has a built-in speaker for convenient communication and alert use.
MIC	The door phone has a built-in microphone hidden in the pinhole located on the front panel.
Card reader area	Use <b>RFID/IC</b> cards to unlock the door by touching <b>Card reader area</b> of device.

### Button Definition

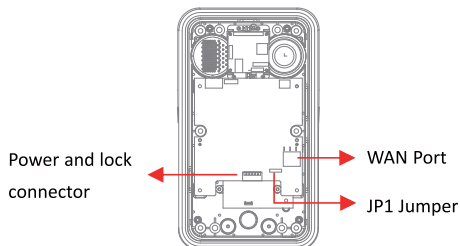
Button	Description
DSS Key	Press the Button, calling or request to open the door.
Numeric Keyboard	Input password to open the door or call.

### LED Definition

LED	Status	Description
 Lock	Steady Blue	Door unlocking
	off	Door locking
 Call	Blinks per second	Hold
	Steady Blue	Call Hold
	off	On Hook
 Ring	Steady Blue	Ringing
	off	On Hook
 Network & SIP Registration	Blinks per second	Network error
	off	Network is normal, SIP is not registered
	Blinks every 3 seconds	SIP Registration failed
	Steady Blue	SIP Registration succeeded

## 2) Port Definition

After removing the Back Panel of device, there are one terminal block connectors for power and lock control connection as shown in the picture below.



## Network Connector



## Power and Electric-lock Connector



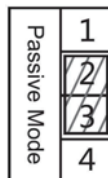
1	2	3	4	5	6	7
+DC12 V	VSS	NC	COM	NO	S-IN	S-OUT
12V DC Input		Electric-lock switch			Indoor switch	

## JP1 Jumper

There are two modes for power supply of electric-lock as shown in the picture below. (The default is “**Passive Mode**”).

**Passive Mode:** When the electric-lock starting current is more than 12V/500mA, need to use the external drive mode, the electric lock interface for short circuit output control.

**Active Mode :** When the electric-lock starting current is less than 12V/500mA, can use the internal drive mode, the electric lock interface is 12V DC output.



**Jumper in passive mode**




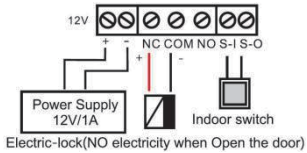

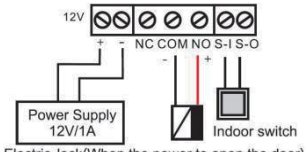

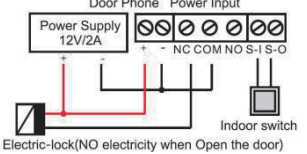

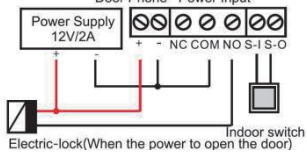

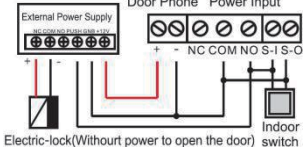
**Jumper in active mode**

## Wiring instructions

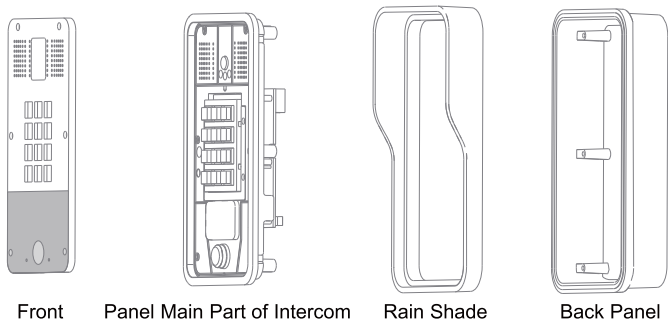
NO: Normally Open Contact

COM: Common Contact

NC: Normally Close Contact

Driving Mode		Electric-lock Mode		JP1 Jumper	Connections
Active	Passive	No electricity when open	Electrify when open		
√		√			 <p>Electric-lock(NO electricity when Open the door)</p>
√			√		 <p>Electric-lock(When the power to open the door)</p>
	√	√			 <p>Electric-lock(NO electricity when Open the door)</p>
	√		√		 <p>Electric-lock(When the power to open the door)</p>
	√	√			 <p>Electric-lock(Without power to open the door)</p>

## 3 Installation



**Figure 1** Three Major Parts of i23S

### Step 1: Installation preparation

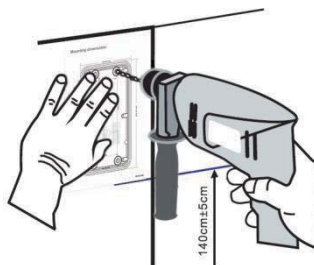
A. Check the following contents:

- Hex screwdriver x 1
- RJ45 plugs x 2 (1 spare)
- TA5 x 40mm screws x 4
- 35mm screw anchors x4

B. Tools that may be required:

- Hex wrench
- Phillips screwdriver (Ph2 or Ph3), hammer, RJ45 crimper
- Electric impact drill with an 6mm drill bit

### Step 2: Drilling

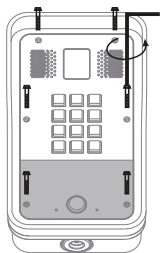


**Figure 2** Wall Mounting

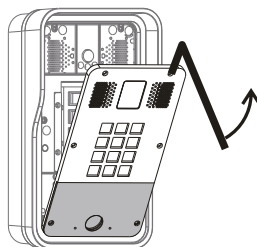
- A. Place the mounting template with dimensions on the surface of a wall in a desired flat position.
- B. Use an electric drill to drill the 4 holes marked on the mounting template. It is recommended to drill about 50mm deep. Remove the template when finishing drilling.  
about 50mm deep. Remove the template when finishing drilling.
- C. Push or hammer screw anchors into the drilled holes.

**Step 3: Removing hanging shell**

- A. With L-shaped screwdriver, unpack the front panel as diagram (3) (Counter-clockwise) and (4)

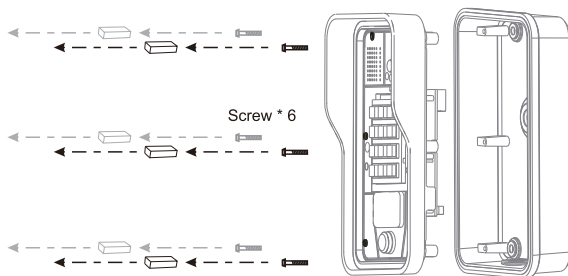


**Figure 3**



**Figure 4**

- B. After taking off the 6 conductive sponges in the plastic shell, use the cross screwdriver to remove the 6 screws on the plastic shell and remove the rain cover from the plastic shell. Then separate the plastic shell from the rear shell as diagram (5).



**Figure 5**

#### Step 4: Back panel fixing and cabling

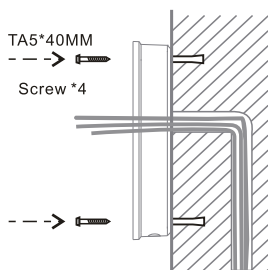


Figure 6

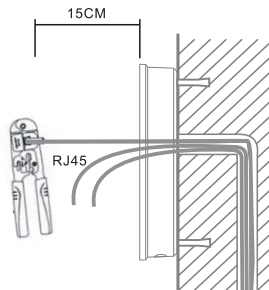


Figure 7

- A. Select the hole for cable supply, 15cm to 20cm cable length is recommended.

Note: The direction of the cable hole on back panel is pointing down.

- B. With 4 TA5\*40mm screws, tighten the back panel on the wall as diagram (6).
- C. Connect the cables of RJ45, power, and electric-lock to the motherboard socket as mentioned in connectors description (refer to Section 2).
- D. Test whether there is electricity by doing the following:  
Press the # button for 3 seconds to get the IP address of intercom by voice.  
Input access password or press the indoor switch to check electric-lock installation.
- Note:** Do not proceed mounting until you have finished the electric checking.

#### Step 4: Mounting

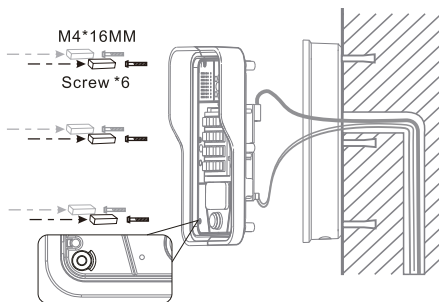


Figure 8

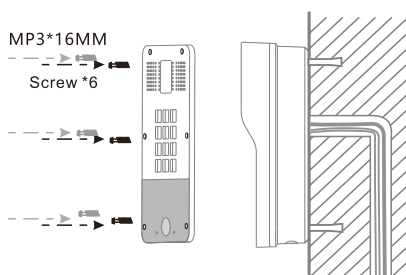


Figure 9

- A. **After locking the 6 screws into the corresponding position of the plastic housing, the 6 conductive sponges is loaded into a screw hole. As shown in Fig. 8, the rear shell is locked.**  
**Note: This sponge can enhance the ESD protection function of the product. Kindly suggest that it should not be ignored!**
- B. Push the front panel into the plastic frame, and tighten it with 6 screws as diagram (9).  
Note: Make sure the screws have been tightened properly for better waterproof effect.

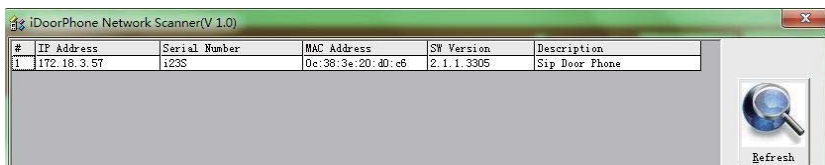
## 4 Searching Door Phone

There are two methods as shown below to search the device.

### Method 1:

Open the iDoorPhone Network Scanner. Press the Refresh button to search the device and find the IP address.

(Download address <http://download.fanvil.com/tool/iDoorPhoneNetworkScanner.exe>)

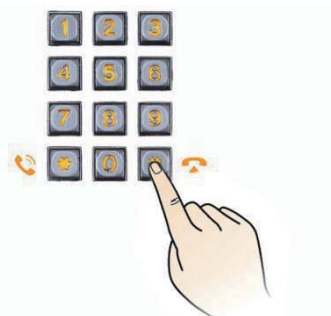


### Method 2:

Press and hold the “#” key for 3 seconds and the door phone will report the IP address by voice.

In addition device provides the device surface DSS key operation to switch IP address acquisition mode:

long press the DSS key for 10 seconds, to be issued by the speaker Beep, and then press the DSS key three times, the beep stops. Wait 10 seconds, after the success of the system automatically broadcast the current IP address.



Default Setting	
Default DHCP Mode	Enable
Static IP Address	192.168.1.128
Default Web Port	80
Default Login User Name	admin
Default Login Password	admin
Display IP address	Hold # for 3 seconds to display by voice
Search Tools	iDoorPhone Network Scanner

## 5 SIP Door Phone Setting

### Step 1: Log in the door phone

Input IP address (e.g. http://192.168.1.149) into address bar of PC's web browser.  
The default user name and password are both admin.



User:   
Password:   
Language: English ▾

### Step 2: Add the SIP account.

Set SIP server address, port, user name, password and SIP user with assigned SIP account parameters.

Select "Activate", and then click Apply to save this setting.



SIP Basic Settings Dial Peer

Line SIP 1 ▾

Basic Settings >>

Line Status	Registered	SIP Proxy Server Address	177.18.1.88
Phone number	5528	SIP Proxy Server Port	5060
Display name	5528	Backup Proxy Server Address	
Authentication Name	5528	Backup Proxy Server Port	5060
Authentication Password	*****	Outbound proxy address	
Activate	<input checked="" type="checkbox"/>	Outbound proxy port	
		Realm	

Codecs Settings >>

Advanced Settings >>

### Step 3: Setting DSS key

Set the DSS key as shown below for a quick start. Click "Apply" to save this setting.

Type: Hot Key

Number 1: The DSS Key will dial to this Number 1.

Number 2: If Number 1 is unavailable, it will be forwarded to Number 2.

Line: Working line

Subtype: Speed dial

The screenshot shows the 'Function Key Settings' configuration page. On the left is a navigation menu with options: System, Network, Line, EGS Setting, EGS Access, EGS Logs, Function Key (selected), and Alert. The main content area is titled 'Function Key Settings' and contains a table with the following data:

Key	Type	Number 1	Number 2	Line	Subtype
DSS Key 1	Hot Key	8102		SIP1	Speed Dial

Below the table are 'Advanced Settings' with the following configurations:

- Use Function Key to Answer: Enable
- Use Hot Key to Hangup: Enable
- Hot Key Dial Mode Select: Main-Secondary
- Call Switched Time: 16 (5-50) Second(s)
- Day Start Time: 00:00 (00:00-23:59)
- Day End Time: 18:00 (00:00-23:59)

An 'Apply' button is located at the bottom right of the settings area.

### Step 4: Door Phone Setting

The screenshot shows the 'Common Settings' configuration page. The left navigation menu is the same as in Step 3, with 'EGS Setting' selected. The top of the page has tabs for Features, Audio, Video, MCAST, Action URL, and Time/Date. The 'Common Settings' section includes the following configurations:

- Switch Mode: Monostable
- Enable Card Reader: Enable
- Card Reader HF Card Data Reverse: Disable
- Limit Talk Duration: Disable
- Remote Password: \*
- APP Door Open: Disable
- Enable Indoor Open: Enable
- Description: Sip Door Phone
- Address of Open Log Server: 0.0.0.0
- Door Unlock Indication: Long Beeps
- Switch-On Duration: 5 (1-600) Second(s)
- Card Reader Working Mode: Normal
- Talk Duration: 120 (20-600) Second(s)
- Local password: \*\*\*\*
- APP Password: \*
- Enable Access Table: Enable
- Enable Open Log Server: Disable
- Port of Open Log Server: 514
- Remote Code Check Length: 4 (1-11)

An 'Apply' button is located at the bottom right. Below the settings are links for 'Basic Settings >>' and 'Block Out Settings >>'.

## 6 Door Unlocking Setting

### 6. Door Unlocking Setting

#### Local

##### 1) Local Password

Step 1: Go to **EGS Setting** → **Features** → Set **Local Password** (The default is “6789”).

Step 2: Use the device’s **Numeric Keyboard** to input **password** and “#” key, and then the door will be unlocked.

The screenshot shows the 'Common Settings' section of the EGS Setting interface. The 'Local password' field is highlighted with a red box and contains the value '6789'. Other settings include 'Switch Mode' (Monostable), 'Switch-On Duration' (5), 'Card Reader Working Mode' (Normal), 'Limit Talk Duration' (Disable), 'Talk Duration' (120), 'Remote Password' (Dropdown), 'APP Door Open' (Disable), 'Enable Indoor Open' (Enable), 'Description' (Slp Door Phone), 'Address of Open Log Server' (0.0.0.0), 'Port of Open Log Server' (514), 'Door Unlock Indication' (Long Beeps), and 'Remote Code Check Length' (4). An 'Apply' button is located at the bottom of the settings area.

##### 2) Private Access Code

Step 1: Go to **EGS Access** → **Access Rule** → set **Access Code**.

Step 2: Use the device’s **Numeric Keyboard** to input **password** and “#” key, and then the door will be unlocked.

The screenshot shows the 'Add Access Rule' section of the EGS Access interface. The 'Access Code' field is highlighted with a red box and contains the value '2233'. Other fields include 'Name' (BBK), 'ID' (0012345678), 'Card State' (Enable), 'Department' (Dropdown), 'Position' (Dropdown), 'Type' (Guest), 'Location' (Dropdown), 'Number' (Dropdown), 'Fwd Number' (Dropdown), 'Double Auth' (Disable), and 'Profile' (None). 'Add' and 'Modify' buttons are at the bottom. A table above shows one access rule with the following data:

Index	Name	ID	Department	Position	Location	Number	Fwd Number	Access Code	Double Auth	Profile	Type	Issuing Date	Card State
1	BBK	0012345678						2233	Disable	None	Guest	2018/02/08	Enable

## Remote

### Remote Password

Step 1: Go to **EGS Setting** → **Features** → **Set Remote Password** (The default is “\*”).

Step 2: To answer the call made by visitor via SIP phone, press the “\*” key to unlock the door the visitor.

The screenshot shows the 'Features' tab in the EGS Setting interface. The 'Remote Password' field is highlighted with a red box and contains an asterisk (\*). Other settings include Switch Mode (Monostable), Enable Card Reader (Enable), Card Reader HF Card Data Reverse (Disable), Limit Talk Duration (Disable), APP Door Open (Disable), Enable Indoor Open (Enable), Description (Sip Door Phone), Address of Open Log Server (0.0.0.0), Door Unlock Indication (Long Beeps), Switch-On Duration (5), Card Reader Working Mode (Normal), Talk Duration (120), Local password (\*\*\*\*), APP Password (\*), Enable Access Table (Enable), Enable Open Log Server (Disable), Port of Open Log Server (514), and Remote Code Check Length (4). An 'Apply' button is visible at the bottom.

## RFID Card

Step 1: Go to **EGS Access** → Enter the Name and ID Number (Only Front 10 yards) → Press **Add** to Access Table.

Step 2: Use pre assigned RFID/IC cards to unlock the door by touching Card reader area of device.

The screenshot shows the 'Import Access Table' page in the EGS Access interface. The 'Add Access Rule' form is highlighted with a red box. The 'Name' field contains 'BBK' and the 'ID' field contains '0012345678'. Other fields include Location, Number, Card State (Enable), Department, Position, Type (Guest), Fwd Number, Access Code (2233), Double Auth (Disable), and Profile (None). 'Add' and 'Modify' buttons are at the bottom.

Index	Name	ID	Department	Position	Location	Number	Fwd Number	Access Code	Double Auth	Profile	Type	Issuing Date	Card State
1	BBK	0012345678						2233	Disable	None	Guest	2018/02/08 16:18:21	Enable

**Note:** If the IC card read data is reverse order, you need to “EGS settings” in the “Card Reader HF Card Data Reverse” open.



**Fanvil Technology Co., Ltd**

Tel: +86-755-2640-2199      Fax: +86-755-2640-2618      Email: [sales@fanvil.com](mailto:sales@fanvil.com)

Add: 4F, Block A, Building 1#, GaoXinQi Hi-Tech Park (Phase-II), 67th District, Bao'An, Shenzhen, China 518101